

**REAL CORP 2017**

Vienna, 2017/09/12



## Employing Spatial Data to Provide Decision Support for SMEs and City Administrations

*Martin Memmel, Andreas Abecker, Sebastian Bretthauer,  
Heinz Kirchmann, Roman Korf, Markus May, Richard Wacker*

# What is SmartRegio?

- Consortium project sponsored by BMWi
- 12/2014 - 05/2017
- Program: "SmartData – Innovations from Data"
  - 13 selected lighthouse projects
  - Development of innovative services and services / fostering a broad use of intelligent, data-based technologies







## **Aim:**

"Decision support for SMEs and administrations on the basis of (freely available) (mass) data about the local environment"



# What is SmartRegio?

[www.smartregio.org](http://www.smartregio.org)



Associated partners:









## Kaiserslautern



Coat of arms



Location of Kaiserslautern in Rhineland-Palatinate [show](#)

Coordinates: 49°26′41″N 7°46′8″E﻿ / ﻿49.44472°N 7.76889°E﻿ / 49.44472; 7.76889

<b>Country</b>	Germany
<b>State</b>	Rhineland-Palatinate
<b>District</b>	Urban district
<b>Government</b>	
<span> </span> • <b>Lord Mayor</b>	Klaus Weichel (SPD)
<b>Area</b>	
<span> </span> • <b>Total</b>	139.72 km <sup>2</sup> (53.95 sq mi)
<b>Elevation</b>	251 m (823 ft)
<b>Population</b> (2015-12-31) <sup>[1]</sup>	
<span> </span> • <b>Total</b>	98,520
<span> </span> • <b>Density</b>	710/km <sup>2</sup> (1,800/sq mi)
<b>Time zone</b>	CET/CEST (UTC+1/+2)
<b>Postal codes</b>	67655–67663
<b>Dialling codes</b>	0631, 06301
<b>Vehicle registration</b>	KL
<b>Website</b>	<a href="http://kaiserslautern.eu">kaiserslautern.eu</a>











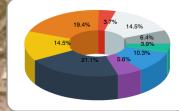
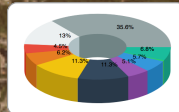
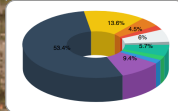
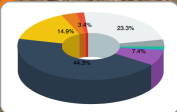
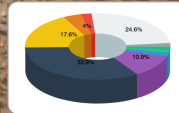
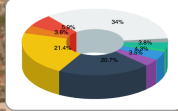
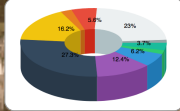
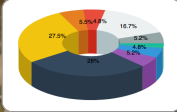
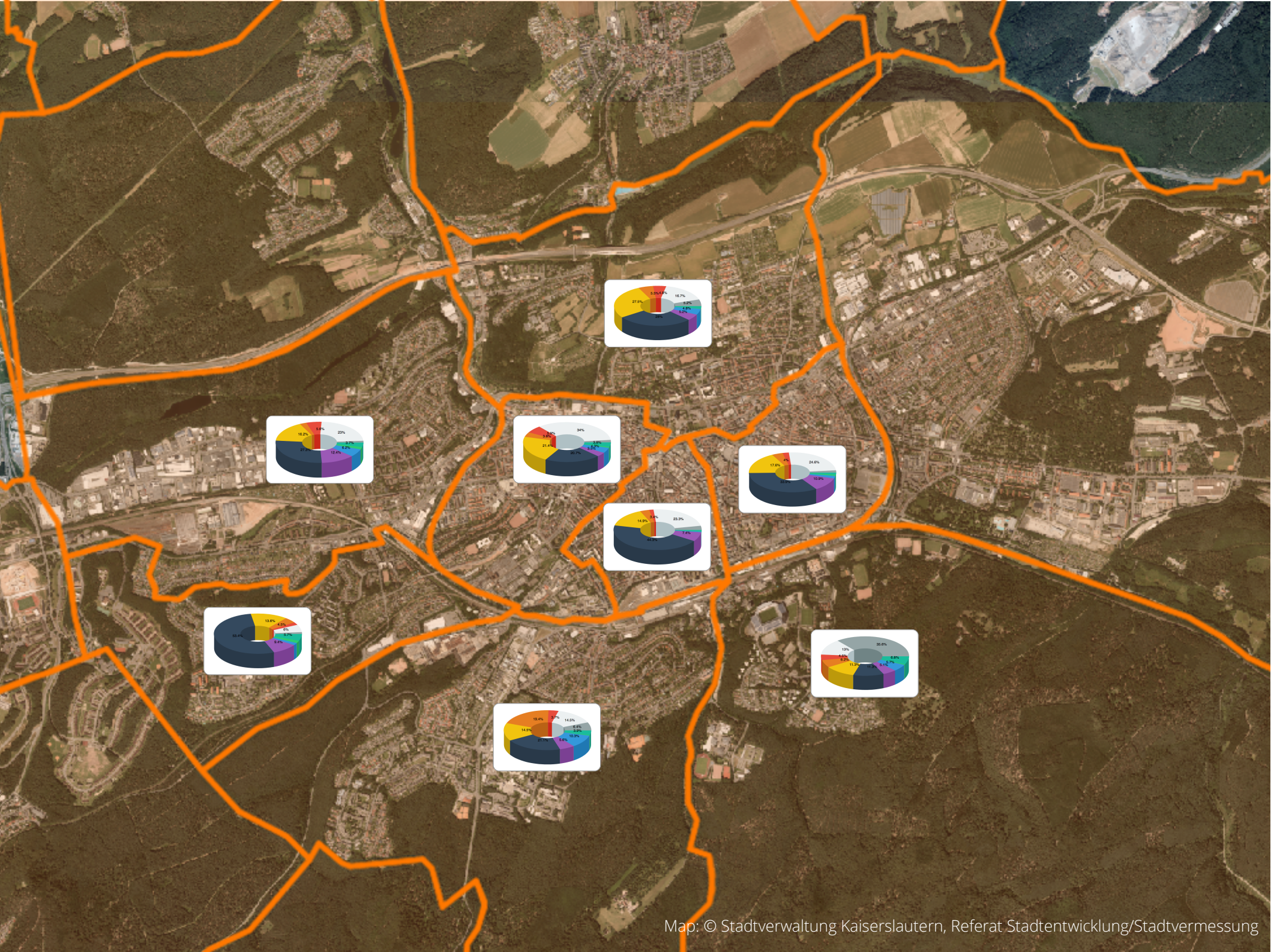







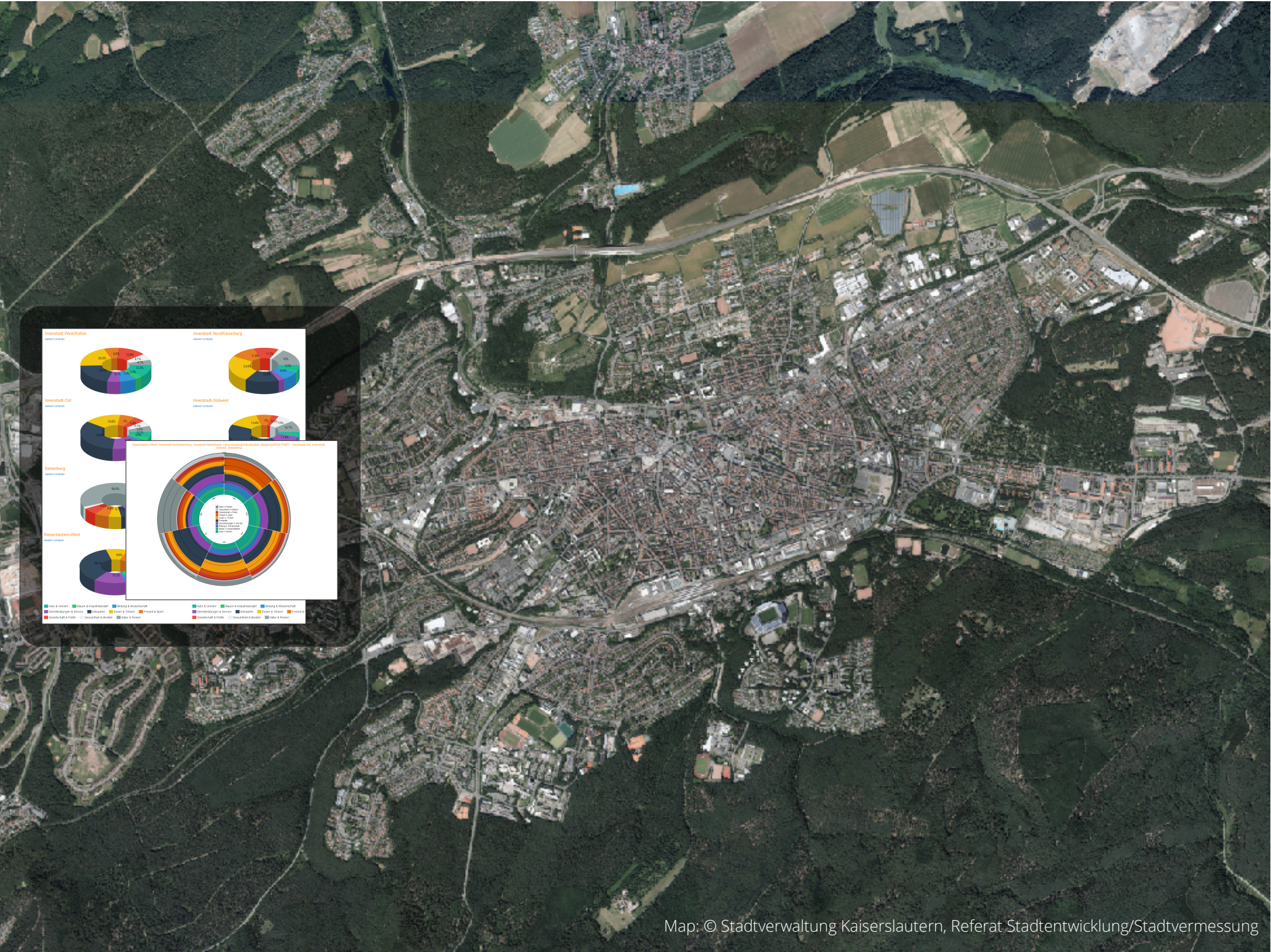



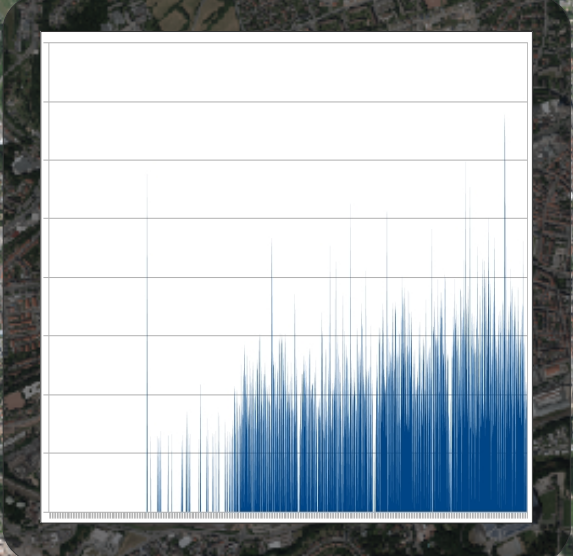
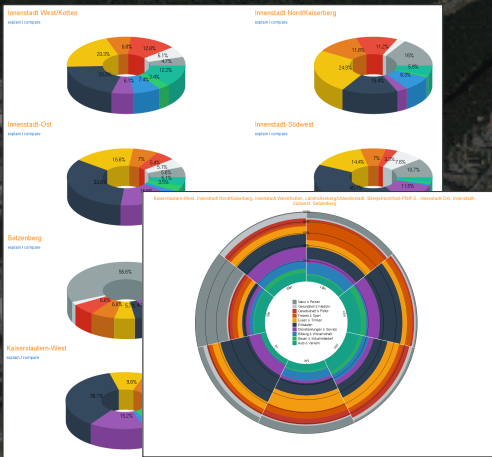







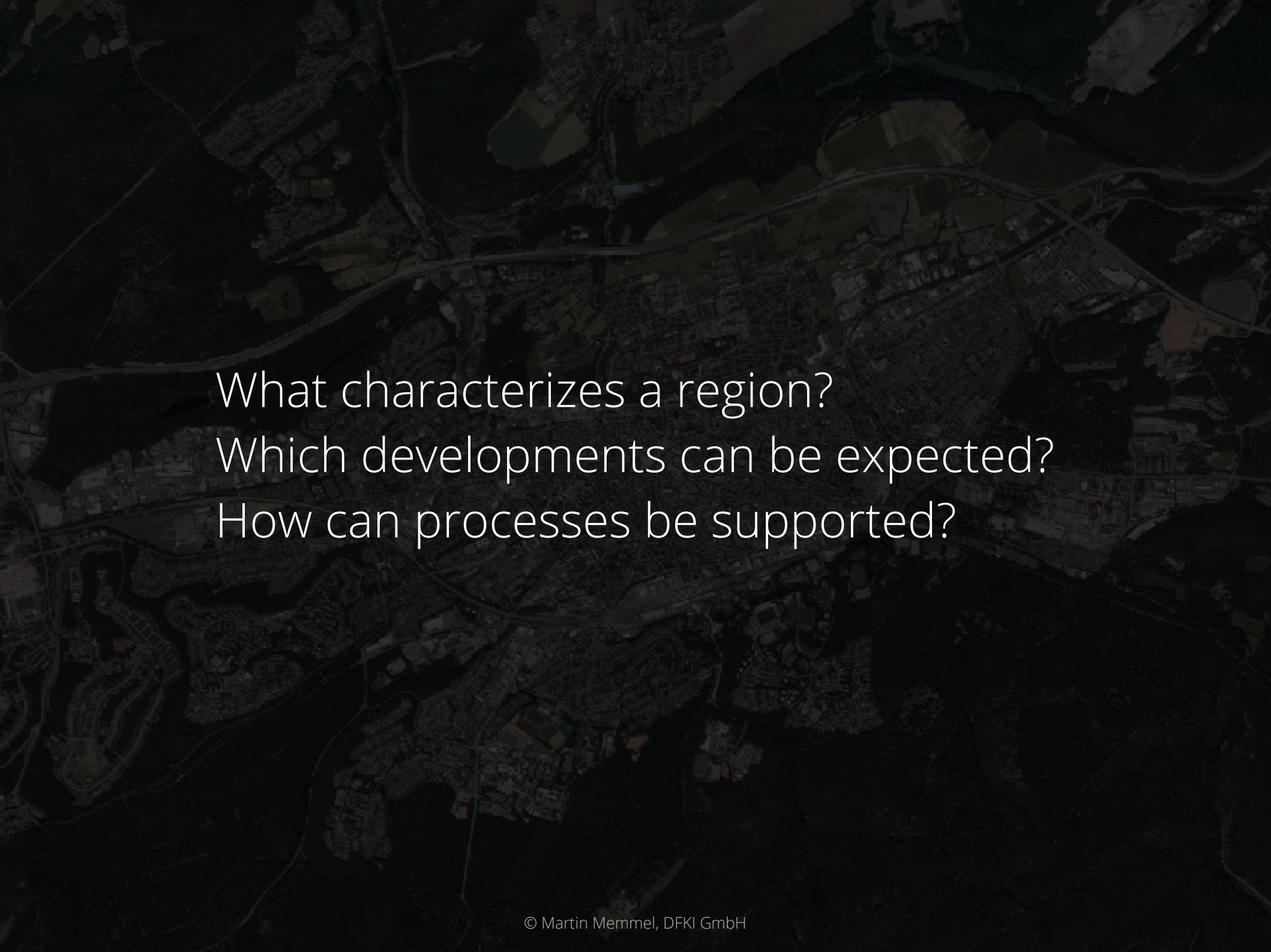

What characterizes a region?  
Which developments can be expected?  
How can processes be supported?







An aerial photograph of a city, likely Frankfurt, showing a dense urban area with a prominent river (the Main) winding through it. The image is darkened with a semi-transparent black overlay, making the text stand out.

What data can be used?



# Data Sources

open sources

closed sources



public



EnergyMap.info

private





# Data Acquisition – Social Media

## Continuous harvesting of Social Media data

- **Twitter:** > 200.000 entries
- **YouTube:** > 5.000 entries
- **OSM:** > 300.000 entries
- **Google My Business:** > 10.000 entries
- Crawled web sites for content analysis: > 130.000





# Potentials & Challenges

- Data acquisition and data integration
  - Heterogeneity is a big issue (as always)
  - OpenData: limited and often unsatisfactory offers
  - Regional vs intraregional? In general: granularity of spatial entities!
  - Social Media APIs are messy & complicated ...
  - In-house: What exists? How to access? What can be used and how?
- Processes
  - **Contact persons in organizations ("Business Understanding") for data mining potentials are essential!**
  - Law / data protection: few established processes, guidelines, etc.
    - very lengthy tuning processes with many bottlenecks (e.g. data protection!)







An aerial photograph of a city, likely a river valley, with a prominent river winding through it. The image is dark and semi-transparent, serving as a background for the text.

# Application Scenarios & Examples



# Sociodemographic Data







Bevölkerungsgruppe: inhabitant\_total



Darstellungstyp: Normalisiert



Animation

Fixed URL

Dimensionen

2010    

01 Innenstadt Ost    

0 - 5 Jahre    

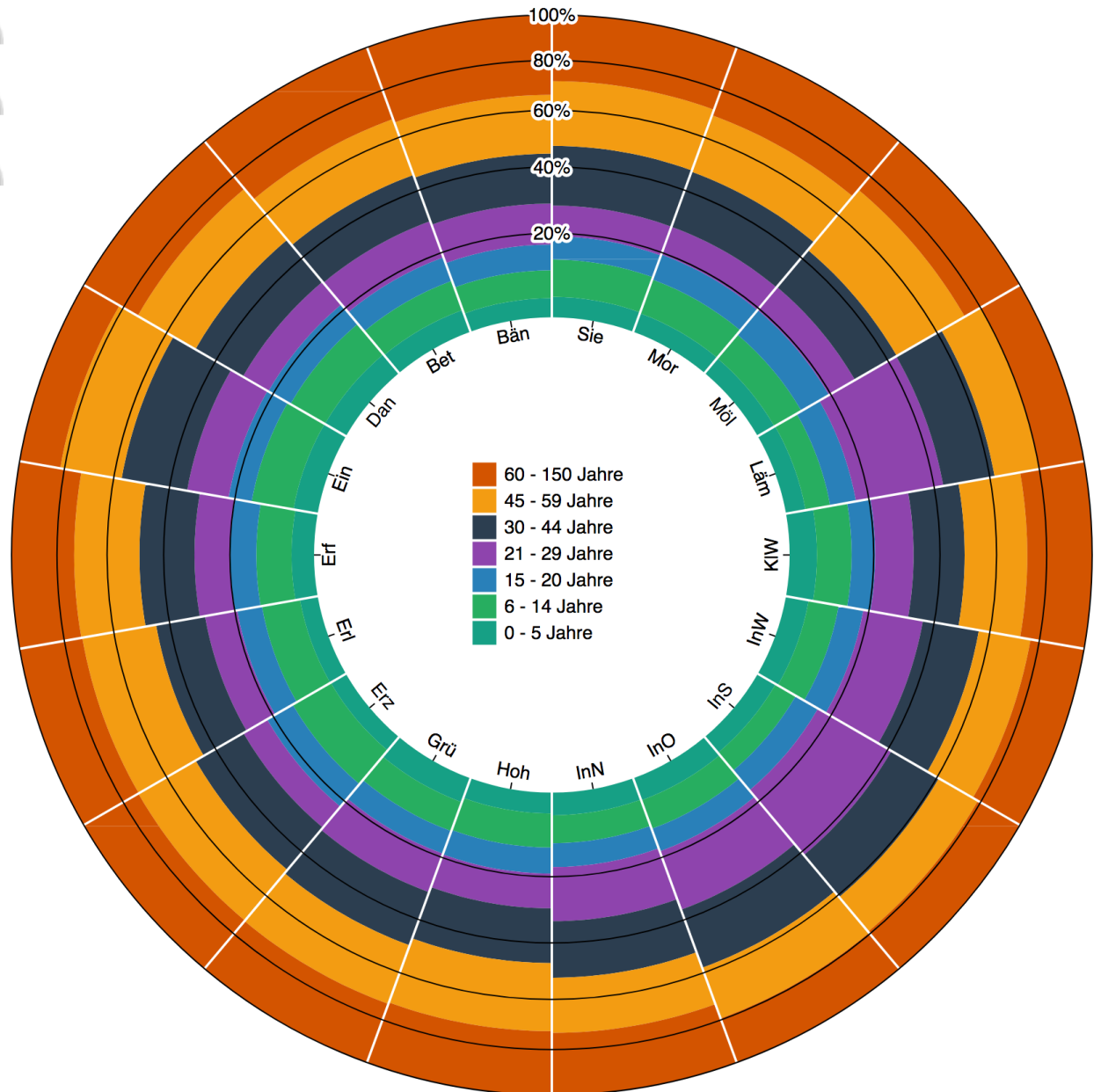





# POI & Timeline Explorer [Social Media / Open Street Maps]







### SmartRegio Spatial Profiler

Stadtteil/Marker:  #Resultate:  Entfernung:  Service:

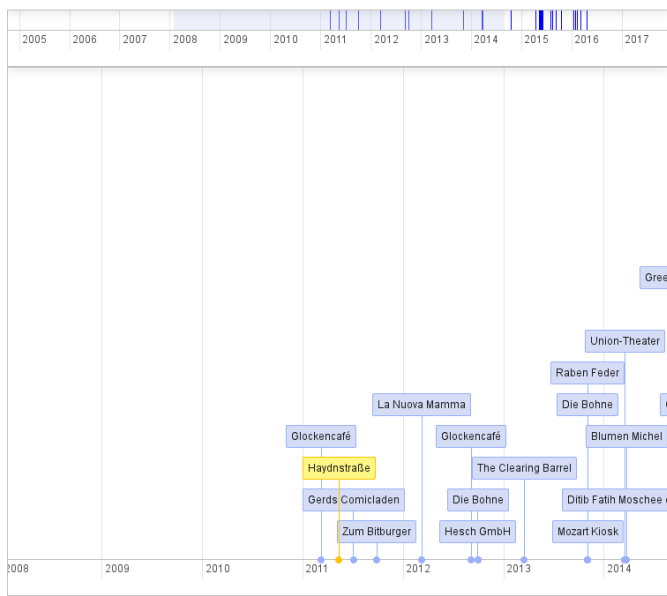
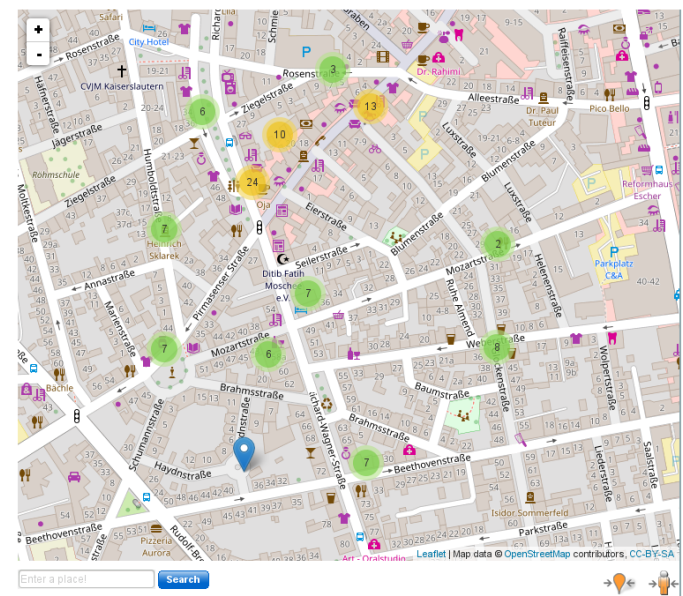

### SmartRegio Spatial Profiler

Stadtteil/Marker:  #Resultate:  Entfernung:  Service:

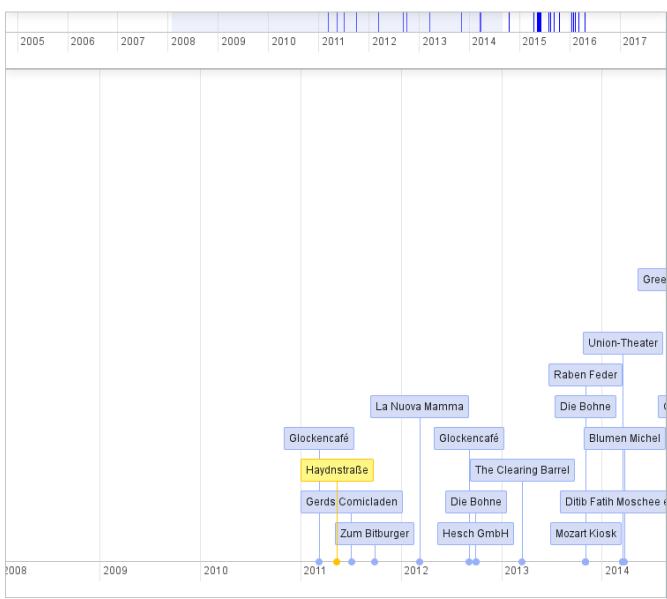
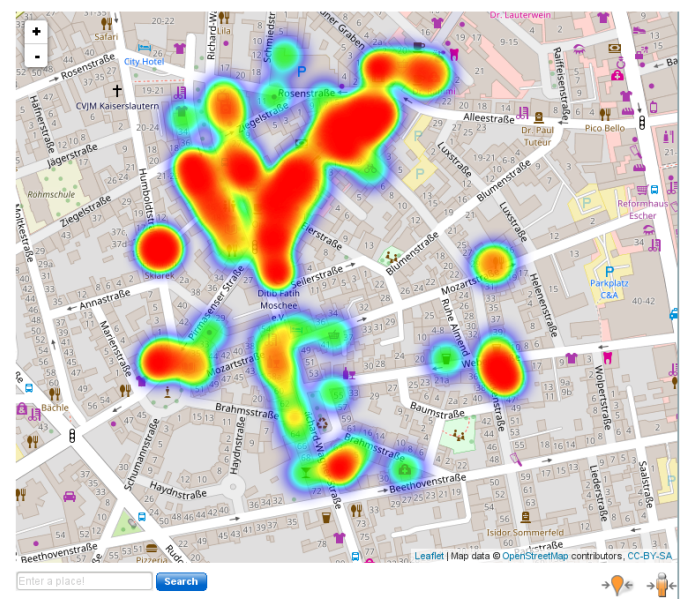



An aerial satellite view of a city, showing a dense urban area with a grid of streets and some green spaces. The image is darkened with a semi-transparent black overlay, making the text stand out.

# Spatial Profiler

## [Social Media / Open Street Maps]







Bänjerrück/Karl-Pfaff-S., Kaiserslautern-West, Innenstadt Nord/Kaiserberg, Innenstadt West/Kotten, Innenstadt-Ost, Innenstadt-Südwest, Lämmchesberg/Uniwohnstadt, Betzenberg

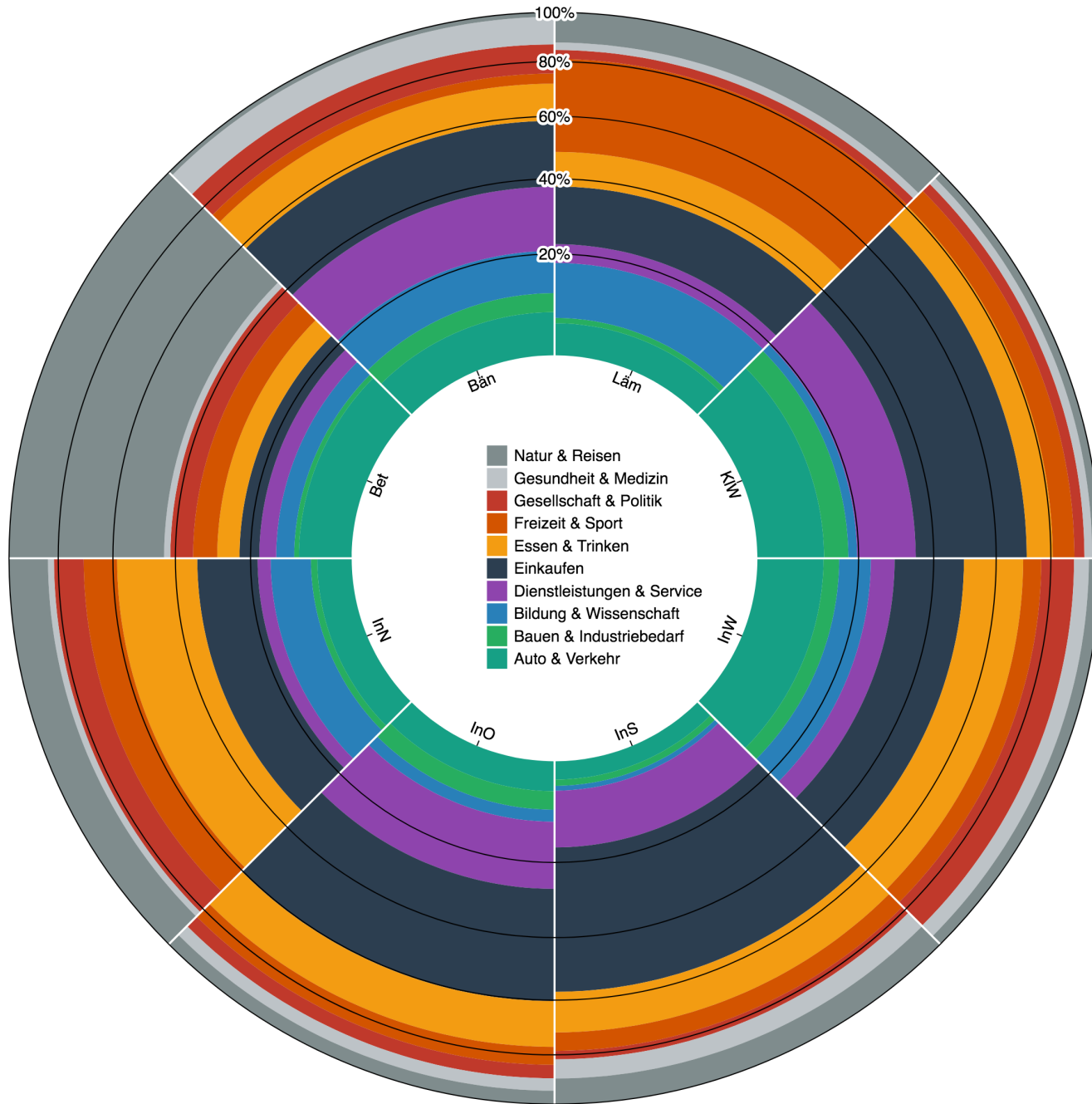



### Bännjerrück/Karl-Pfaff-S.

[explain](#) / [compare](#)

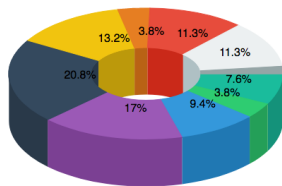

Auto & Verkehr Bauen & Industriebedarf Bildung & Wissenschaft Dienstleistungen & Service  
Einkaufen Essen & Trinken Freizeit & Sport Gesellschaft & Politik  
Gesundheit & Medizin Natur & Reisen

### Kaiserslautern-West

[explain](#) / [compare](#)

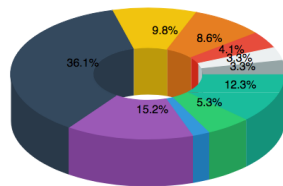

Auto & Verkehr Bauen & Industriebedarf Bildung & Wissenschaft Dienstleistungen & Service  
Einkaufen Essen & Trinken Freizeit & Sport Gesellschaft & Politik  
Gesundheit & Medizin Natur & Reisen

### Innenstadt Nord/Kaiserberg

[explain](#) / [compare](#)

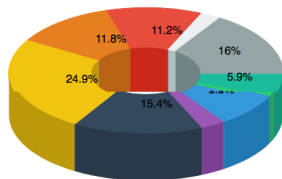

Auto & Verkehr Bauen & Industriebedarf Bildung & Wissenschaft Dienstleistungen & Service  
Einkaufen Essen & Trinken Freizeit & Sport Gesellschaft & Politik  
Gesundheit & Medizin Natur & Reisen

### Innenstadt West/Kotten

[explain](#) / [compare](#)

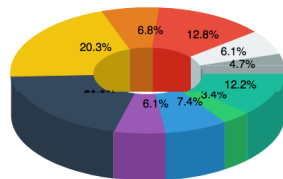

Auto & Verkehr Bauen & Industriebedarf Bildung & Wissenschaft Dienstleistungen & Service  
Einkaufen Essen & Trinken Freizeit & Sport Gesellschaft & Politik  
Gesundheit & Medizin Natur & Reisen

### Innenstadt-Ost

[explain](#) / [compare](#)

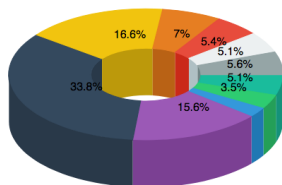

Auto & Verkehr Bauen & Industriebedarf Bildung & Wissenschaft Dienstleistungen & Service  
Einkaufen Essen & Trinken Freizeit & Sport Gesellschaft & Politik  
Gesundheit & Medizin Natur & Reisen

### Innenstadt-Südwest

[explain](#) / [compare](#)

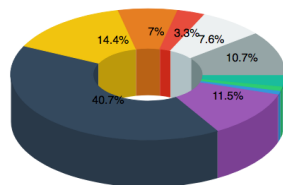

Auto & Verkehr Bauen & Industriebedarf Bildung & Wissenschaft Dienstleistungen & Service  
Einkaufen Essen & Trinken Freizeit & Sport Gesellschaft & Politik  
Gesundheit & Medizin Natur & Reisen

### Lämmchesberg/Uniwohnstadt

[explain](#) / [compare](#)

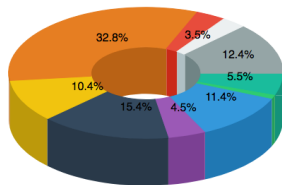

Auto & Verkehr Bauen & Industriebedarf Bildung & Wissenschaft Dienstleistungen & Service  
Einkaufen Essen & Trinken Freizeit & Sport Gesellschaft & Politik  
Gesundheit & Medizin Natur & Reisen

### Betzberg

[explain](#) / [compare](#)

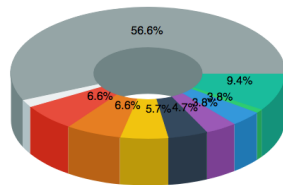

Auto & Verkehr Bauen & Industriebedarf Bildung & Wissenschaft Dienstleistungen & Service  
Einkaufen Essen & Trinken Freizeit & Sport Gesellschaft & Politik  
Gesundheit & Medizin Natur & Reisen



# Betzenberg

[explain / compare](#)

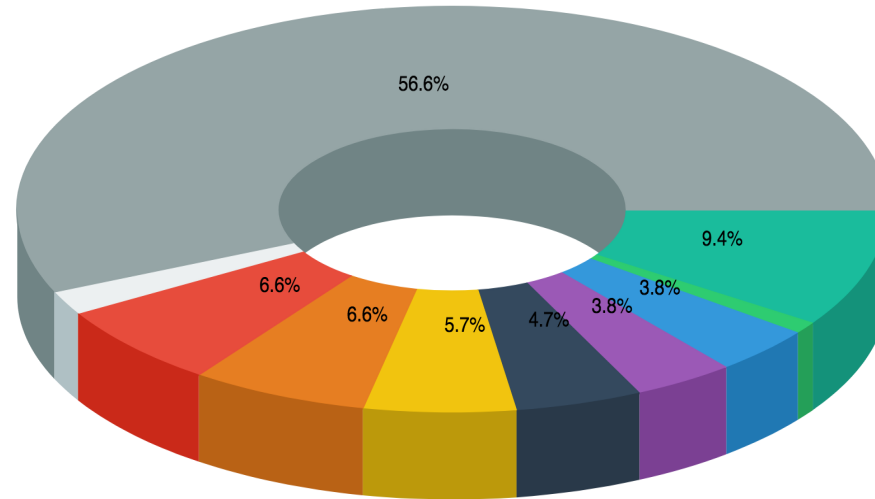

- Auto & Verkehr
- Bauen & Industriebedarf
- Bildung & Wissenschaft
- Dienstleistungen & Service
- Einkaufen
- Essen & Trinken
- Freizeit & Sport
- Gesellschaft & Politik
- Gesundheit & Medizin
- Natur & Reisen



# Betzenberg

[explain / compare](#)

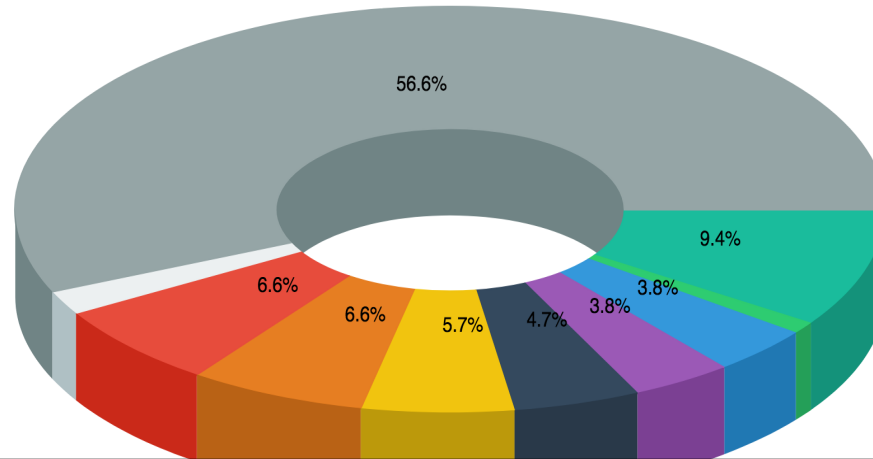

## Abweichung vom Gesamtmittel

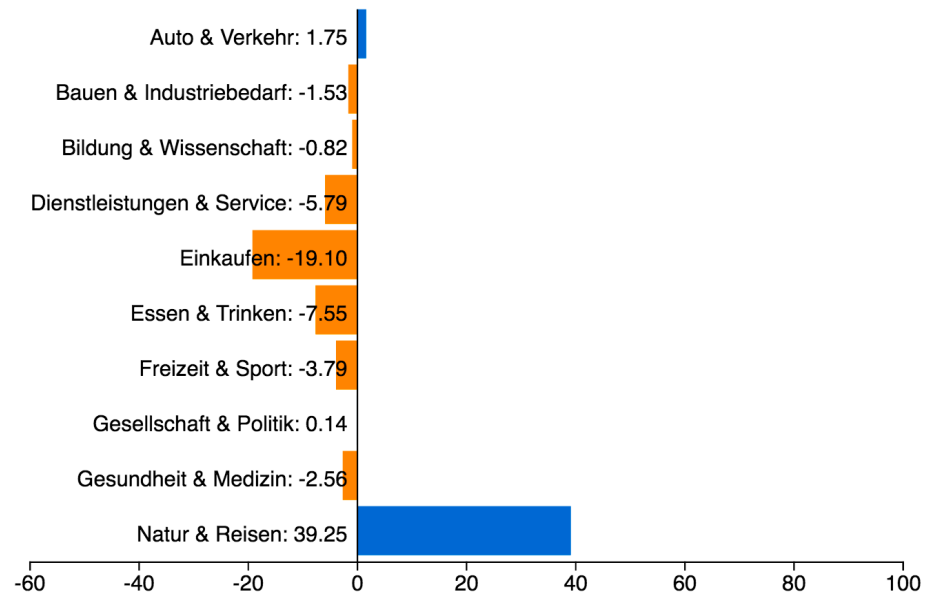

Auto & Verkehr  
Bauen & Industriell  
Natur & Reisen

Gesellschaft & Politik  
Gesundheit & Medizin



# Media Analysis







## Soziale Medien durchsuchen

Suchkataloge
SWK Facebook <span>✖</span>
Twitter KL alles <span>✖</span>
SWK Twitter Google+ <span>✖</span>
SWK Twitter Google+ weltweit <span>✖</span>
SWK Google+ <span>✖</span>
<a href="#">+ Neuen Katalog anlegen</a>

Suchanfragen	
Suche	Löschen
Grüner	✖
CNG	✖
Erdgas	✖
Gas	✖
Gasaustritt	✖
Wassercent	✖
Wasser	✖
Heizöl	✖
Ölpreis	✖
Solarstrom	✖
Strom	✖
Strompreis	✖
Fernwärme	✖
Elektromobilität	✖
E-mobility	✖
E-Autos	✖
E-Auto	✖
Blockheizkraftwerk	✖
Ökostrom	✖
Heizölbörse	✖
Ölpreis	✖
EEG	✖
Erneuerbare Energien	✖
ASK	✖

Quellen
Facebook <span>▼</span> <span>✖</span>
swk.kl.de <span>✖</span>
gartenschau.kl <span>✖</span>
JapanischerGarten <span>✖</span>
montemare.kaiserslautern <span>✖</span>
pb.kaiserslautern <span>✖</span>
ZooGesellschaftKaiserslauternMbh <span>✖</span>
RockTown.eu <span>✖</span>
Kinder-Spiel-und-Spess-Fabrik/164466053592887 <span>✖</span>
WorldofLaserKaiserslautern <span>✖</span>
LERNACADEMY <span>✖</span>
K1Waldseilpark <span>✖</span>
tus04dansenberg <span>✖</span>
FCK-Rolling-Devils/169800396366053 <span>✖</span>
KammgarnKaiserslautern <span>✖</span>
exitadventures <span>✖</span>
Golfclub-Pf%C3%A4lzerwald/192563614121858 <span>✖</span>
MusikvereinKaiserslautern1840eV <span>✖</span>
Nachrichten.KL <span>✖</span>
Citykit <span>✖</span>
Verbandsgemeinde-Otterbach-Otterberg-697633707014267 <span>✖</span>
KnetGmbH <span>✖</span>
WNS-Westfälische-Nahverkehrs-Service-GmbH.135525793210870 <span>✖</span>





## Soziale Medien - gefundene Inhalte

Suchkatalog:

SWK Twitter Google+

1

Beiträge (45)

Inhalte des Katalogs löschen

Inhalte in Timeline anzeigen

Inhalte auf Karte anzeigen

Facebook

Twitter

Google



**Dirk** 11. Juli 2016, 01:57:15 (83)  
Stell mir eine Frage | <https://t.co/BTIq1etxB>

0



**Saminator** 10. Juli 2016, 22:39:54 (499)  
RT @razetVlog: Bei so gutem Wetter möchte man einfach nur ans Wasser ☐ kennt ihr die Sehnsucht? ☐

9



**MVDI** 10. Juli 2016, 22:38:49 (1174)  
RT @razetVlog: Bei so gutem Wetter möchte man einfach nur ans Wasser ☐ kennt ihr die Sehnsucht? ☐

9



**broken skull** 10. Juli 2016, 15:03:11 (137)  
RT @razetVlog: Bei so gutem Wetter möchte man einfach nur ans Wasser ☐ kennt ihr die Sehnsucht? ☐

9



**Hannah** 10. Juli 2016, 14:37:06 (1078)  
RT @razetVlog: Bei so gutem Wetter möchte man einfach nur ans Wasser ☐ kennt ihr die Sehnsucht? ☐

9



**Tina** 10. Juli 2016, 14:28:22 (295)  
RT @razetVlog: Bei so gutem Wetter möchte man einfach nur ans Wasser ☐ kennt ihr die Sehnsucht? ☐

9



**so 'ne dolle ☺** 10. Juli 2016, 14:27:15 (399)  
RT @razetVlog: Bei so gutem Wetter möchte man einfach nur ans Wasser ☐ kennt ihr die Sehnsucht? ☐

9



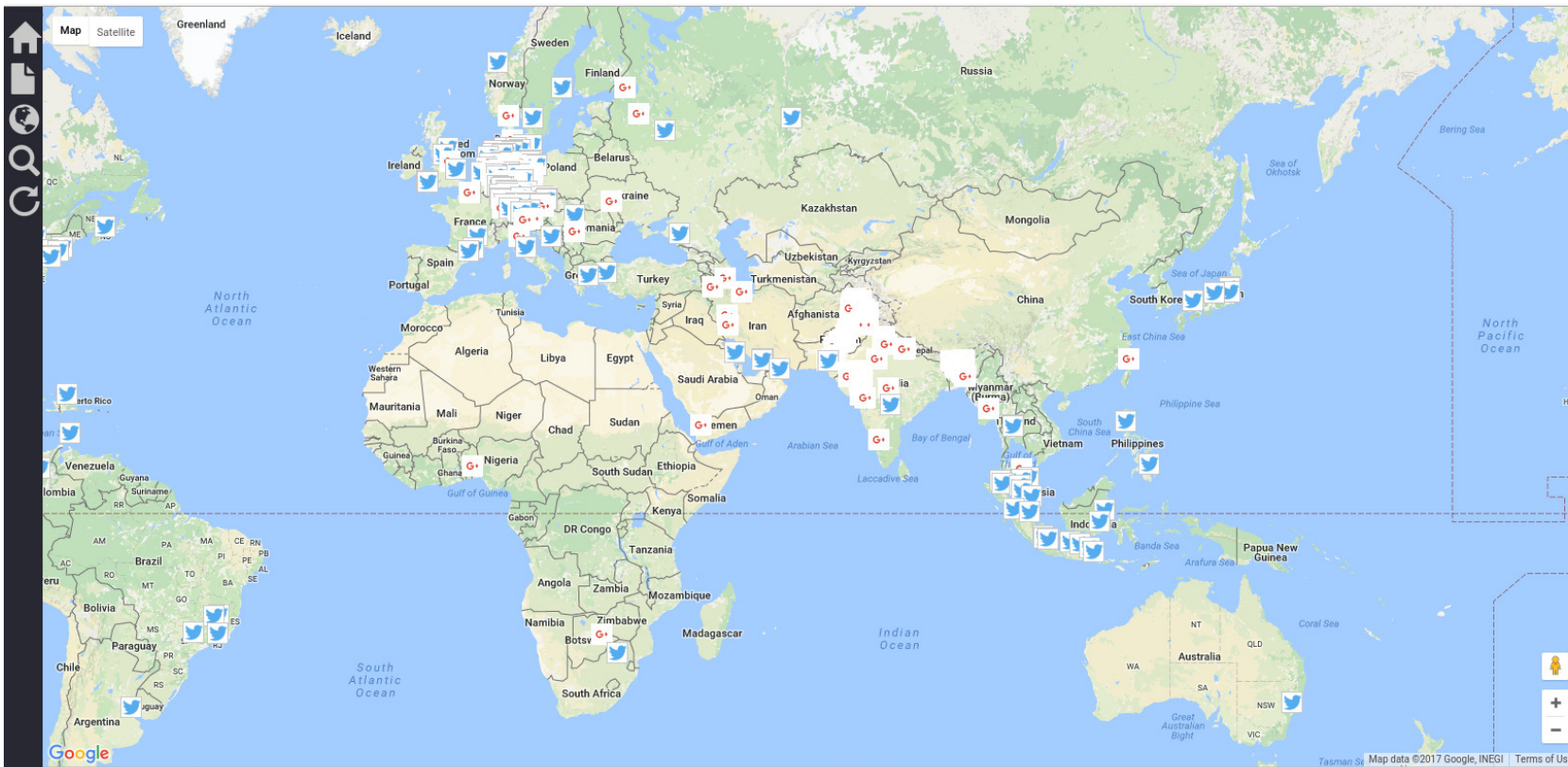

**Suchkatalog**

SWK Twitter Google+ weltweit

---

**Quellen**

- Facebook
- Twitter
- Google+

---

- Beiträge
- Heatmap

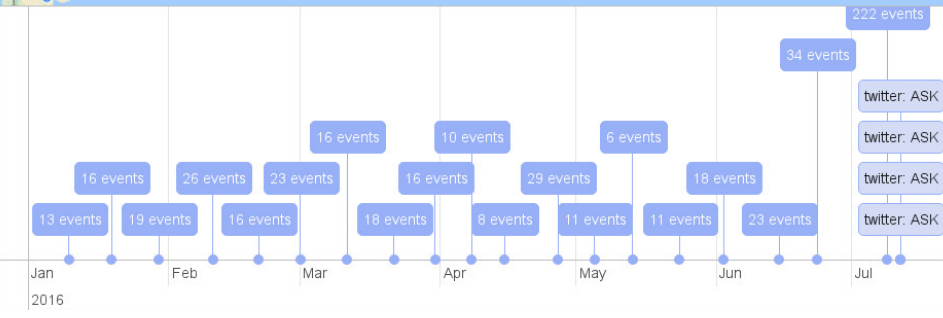





# Architecture & Technology



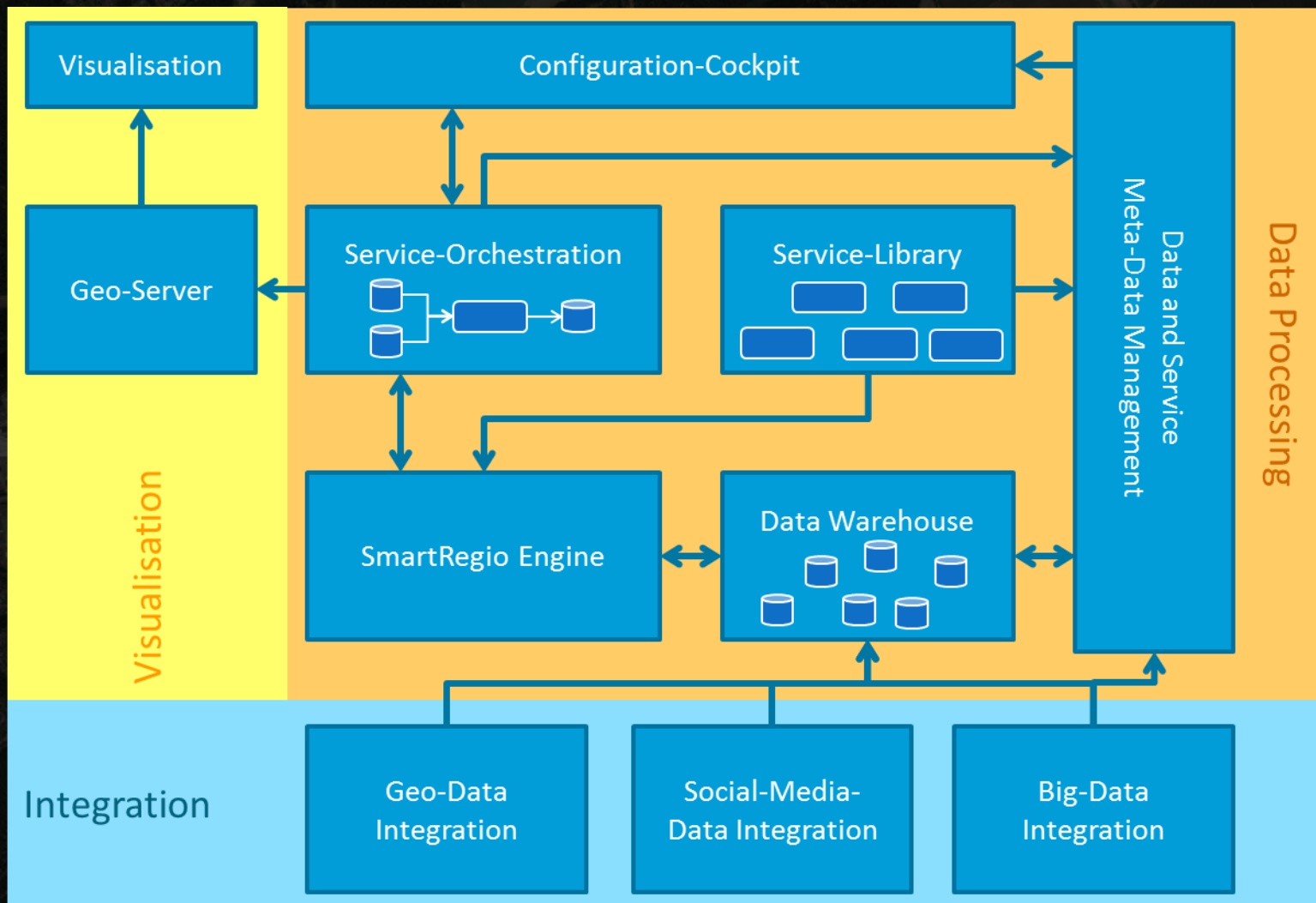



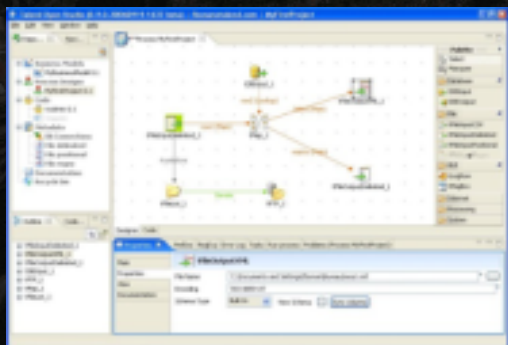

Talend OpenStudio

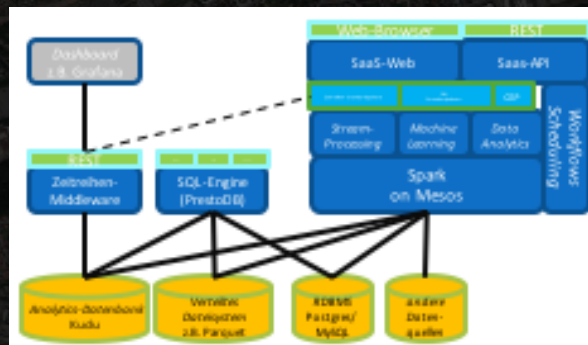

USU Big Data

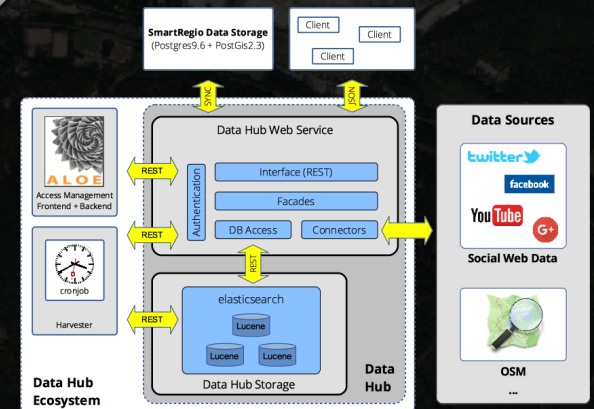

DFKI Data Hub



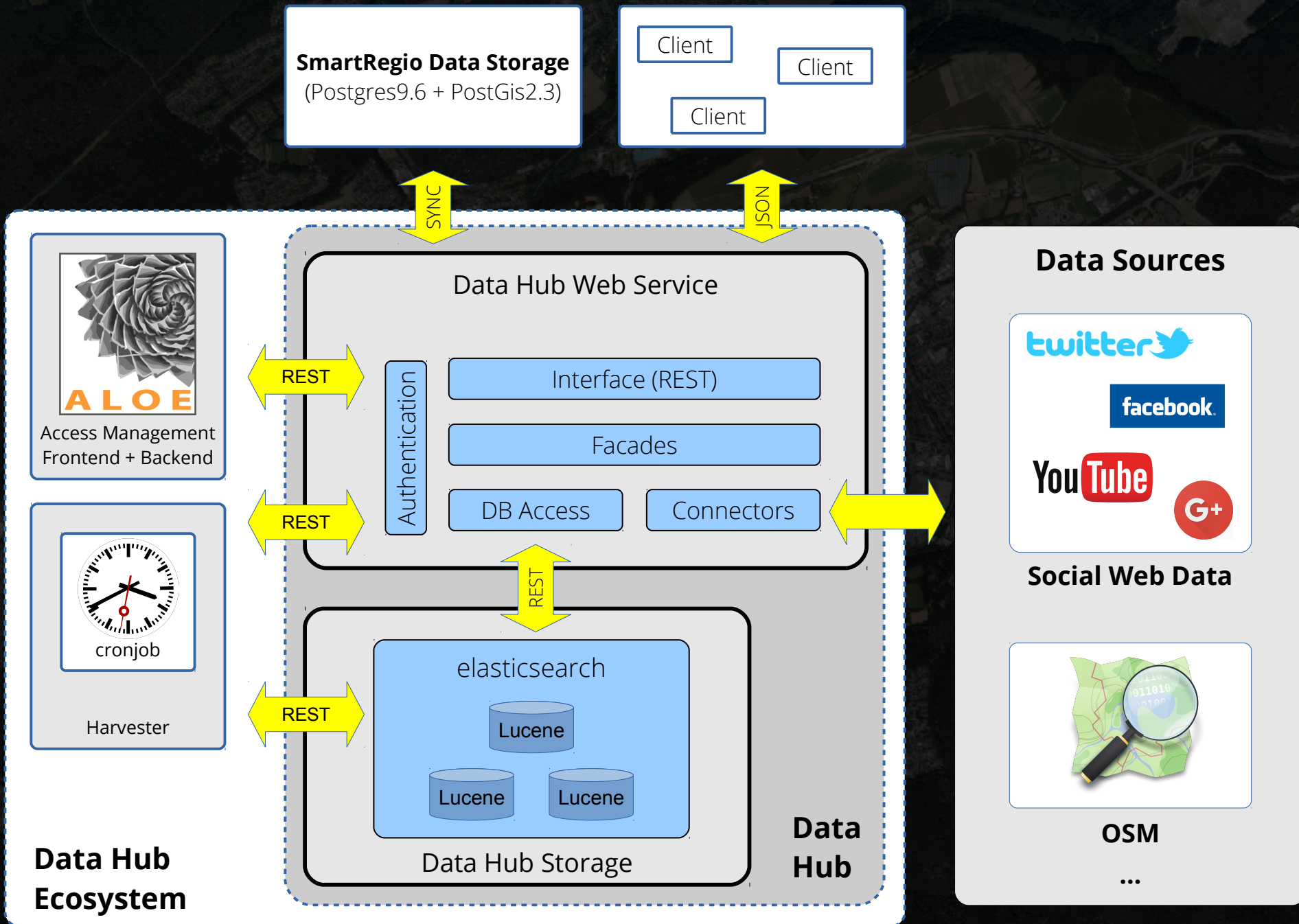



# Data integration with kibana

The image displays two screenshots of the Kibana interface. The top screenshot shows a heatmap visualization of 'smartregio\_google\_places' data, with a color scale ranging from blue (low density) to red (high density). The bottom screenshot shows a bar chart visualization of 'smartregio\_openstreetmap' data, with a time range from April 2016 to April 2017. The bar chart shows a significant spike in activity around June 2016. Below the bar chart, a list of data points is visible, including details such as name, address, and coordinates.

**smartregio\_google\_places**

**smartregio\_openstreetmap**

3,484 hits

Time -

June 12th 2016, 12:11:39.000

June 12th 2016, 20:36:59.000

June 12th 2016, 20:36:57.000

June 9th 2016, 10:11:44.000

June 7th 2016, 12:15:50.000

June 7th 2016, 12:12:09.000

June 7th 2016, 12:12:09.000

June 7th 2016, 12:09:00.000

June 7th 2016, 12:07:00.000



kibana



# Summary & Conclusions

- There is of course no simple solution :)
- Availability of sources & quality of data are a problem
- Creation of common spatial references is crucial
- Generic approaches make sense for many use cases
- Long term engagement and strategy is required
- Continuous dialogue between technical experts and users / domain experts
- Working with data requires acting with responsibility





# Thank you for your attention!

...we love to do this - collaborations are very welcome!

Dr. Martin Memmel  
[martin.memmel@dfki.de](mailto:martin.memmel@dfki.de)

Smart Data & Knowledge Services  
DFKI GmbH, Kaiserslautern  
[www.dfki.de](http://www.dfki.de)